



REHAU®

Unlimited Polymer Solutions



EXPRESS COLLECTION

ROLLER SHUTTER SYSTEMS FOR CREATIVE INTERIOR DESIGN

DESIGN FOR FURNITURE

INNOVATIVE SYSTEM SOLUTIONS FROM ONE SOURCE

REHAU has established itself as a leading manufacturer and supplier of innovative system solutions for a great variety of different applications in the furniture industry, commerce and trade.

With Express Collection REHAU supports its partners from commerce and trade. The attractive standard product range offers a comprehensive selection of products and services.

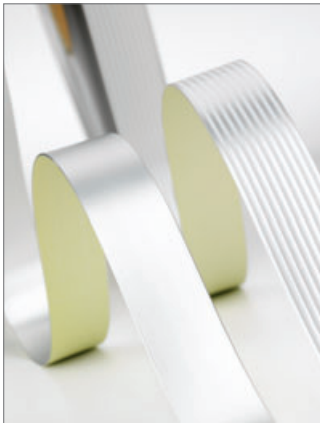

Everything from one source

In the REHAU Express Collection you will find a wide range of

- RAUKANTEX edgeband materials and tools
 - RAUVOLET roller shutter systems
 - RAUSOLID solid surface materials
 - RAUWALON wall seal systems
- and much more.

Quick, flexible, small quantities

The REHAU Express Collection scores particularly highly with its short lead times and quantities tailored to requirements. These enable to meet your customer's requirements quickly and flexibly.

Design variety and design expertise

The diverse product range and the multifaceted colour and decor range is constantly being further developed through innovations and is being adapted to current market trends all the time.

With matching designs across different products REHAU underlines its expertise and at the same time its claim with regard to function and design. In addition, the edgeband product range is

coordinated with the current board and laminate designs and included in our extensive collection network.

Advancement through knowledge

We secure your advancement through knowledge with the REHAU Academy. At seminars and other events you can get technical support and advice as well as processing support in every aspect of the REHAU Express Collection.

In short:

the REHAU Express Collection offers high performance in every respect. Why not take advantage of it?



horizontal application

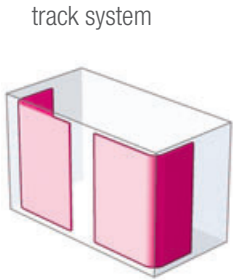

	internal						front		
	recessed		surface mounted		front mounted				
	Classic				Top		Top Basic	Frame	
Shutter thickness	8 mm		12 mm		8 mm		8 mm	8 mm	
Rear wall / side wall	RW	SW	RW	SW	RW	SW	RW	RW	SW

Design range

metallic-line	<input type="checkbox"/>	<input type="checkbox"/>			<input type="checkbox"/>	<input type="checkbox"/>	<input style="border: 1px solid black;" type="checkbox"/>	<input type="checkbox"/>	<input type="checkbox"/>
creative-line	<input type="checkbox"/>	<input type="checkbox"/>			<input type="checkbox"/>	<input type="checkbox"/>	<input style="border: 1px solid black;" type="checkbox"/>	<input type="checkbox"/>	<input type="checkbox"/>
decor-line	<input type="checkbox"/>	<input type="checkbox"/>	<input type="checkbox"/>	<input type="checkbox"/>	<input type="checkbox"/>	<input type="checkbox"/>	<input type="checkbox"/>	<input type="checkbox"/>	<input type="checkbox"/>
color-line	<input type="checkbox"/>	<input type="checkbox"/>	<input type="checkbox"/>	<input type="checkbox"/>	<input type="checkbox"/>	<input type="checkbox"/>	<input type="checkbox"/>	<input type="checkbox"/>	<input type="checkbox"/>



vertical application

	individual size				sets
	Frame				
Shutter thickness	8 mm				8 mm
	Vertical brake	C6	Caddy brake	C3	C-Box

Design range

metallic-line		<input style="background-color: #ccc;" type="checkbox"/>	<input style="background-color: #ccc;" type="checkbox"/>	<input style="background-color: #ccc;" type="checkbox"/>	<input style="background-color: #ccc;" type="checkbox"/>
creative-line			<input style="background-color: #ccc;" type="checkbox"/>	<input style="background-color: #ccc;" type="checkbox"/>	
decor-line	<input style="background-color: #ccc;" type="checkbox"/>	<input style="background-color: #ccc;" type="checkbox"/>	<input style="background-color: #ccc;" type="checkbox"/>	<input style="background-color: #ccc;" type="checkbox"/>	
color-line	<input style="background-color: #ccc;" type="checkbox"/>	<input style="background-color: #ccc;" type="checkbox"/>	<input style="background-color: #ccc;" type="checkbox"/>	<input style="background-color: #ccc;" type="checkbox"/>	



EXPRESS COLLECTION

ROLLER SHUTTER SYSTEMS FOR CREATIVE INTERIOR DESIGN

Contents

1	Freedom in cabinet design	6
2	Overview of roller shutter profiles and design ranges	8
3	Horizontal fitting	10
	Classic	12
	Top + Top Basic	14
	Frame	16
4	Vertical fitting	18
	Vertical brake	20
	C6	21
	Caddy brake	22
	C3 roller mechanism	24
5	Accessories	30
6	Packaging / availability	31
7	RAUVOLET metallic-line:	32
	Ready-to-fit sets	
8	Article overview and profile cross-sections	34
9	Every aspect of the Express Collection	38
10.	Contacts	40

With the RAUVOLET standard range from Express Collection, REHAU provides perfectly matching roller shutter systems for individual cabinet design.



Roller shutter profiles, accessories, track variants, colours and sizes can be individually combined due to the modular compatibility of our product. This gives you freedom in the design of cabinets for offices, kitchens, bathrooms and living rooms, and also for sophisticated projects and interior architecture.

Four design ranges determine the appearance:

- **metallic-line**, for the cool look in genuine aluminium and stainless steel.
- **creative-line**, excelling in translucent white.
- **decor-line**, encompassing printed variants in: maple, cherry, birch, cherry-Havana, calvados, beech and aluminium.
- **color-line**, containing the three common plain colours: grey, white, and black.

RAUVOLET also stands for flexibility of the track system.

You have a choice of three different types of horizontal fitting:

- **Classic**: the recessed track
- **Top**: the surface-mounted track
- **Frame**: the front-mounted track

Frame offers a completely new appearance in an unusual framed look. Particularly in combination with RAUVOLET metallic-line, this achieves an exclusive appeal with a full metal appearance.

For **vertical applications**, RAUVOLET offers numerous well-known vertical systems for individual cabinet design. This is ideal for project work with ready-to-fit sets for kitchens.



ROLLER SHUTTERS AND DESIGN RANGES

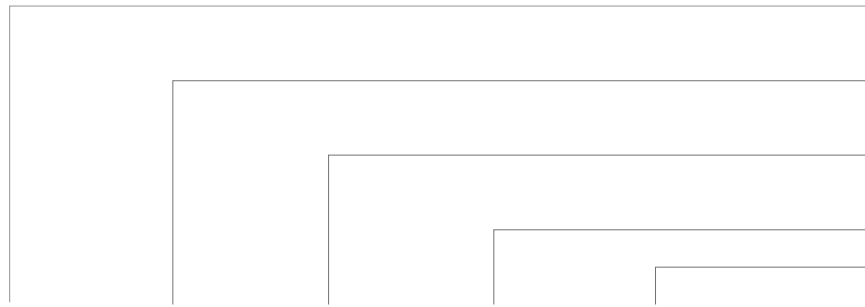

	E4	SE16	E23	metallic-line 20	metallic-line 25 mm
shutter thickness (track system)	12 mm	12 mm	8 mm	8 mm	8 mm

Design range	Colour	horizontal application			vertical application	
		E4	SE16	E23	metallic-line 20	metallic-line 25 mm
metallic-line	aluminium E6EV1				■	■
	stainless steel				sets only	sets only
creative-line	20004 translucent			■		
decor-line	aluminium 5427	■	■	■		
	birch 5514			■		
	maple 7376			■		
	beech 5018	■	■	■		
	cherry-Havana 053W			■		
	cherry 5429			■		
	calvados 5797			■		
	color-line	white RAL 9010		■	■	
grey RAL 7035	■	■	■			
black RAL 9011	■	■	■			

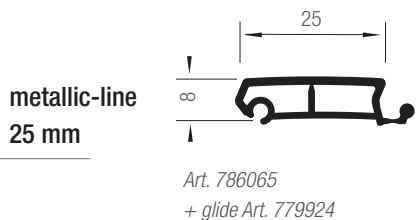
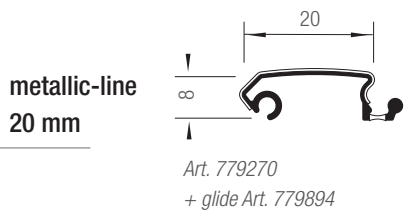
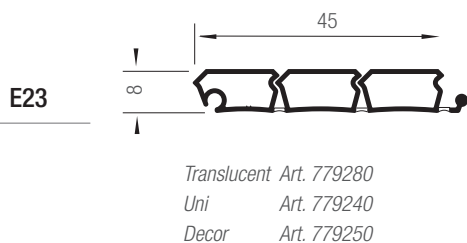
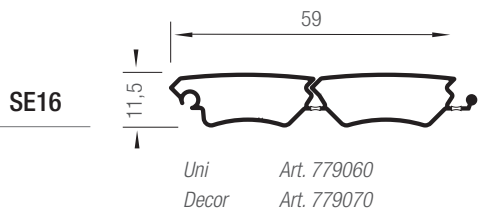
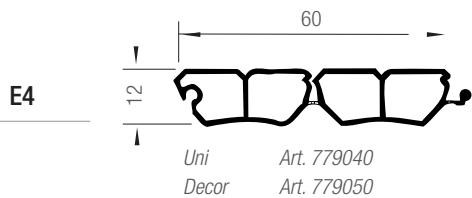

RAUVOLET E4



RAUVOLET SE16



RAUVOLET E23



RAUVOLET metallic-line 20 mm



RAUVOLET metallic-line 25 mm

Recommended for horizontal applications

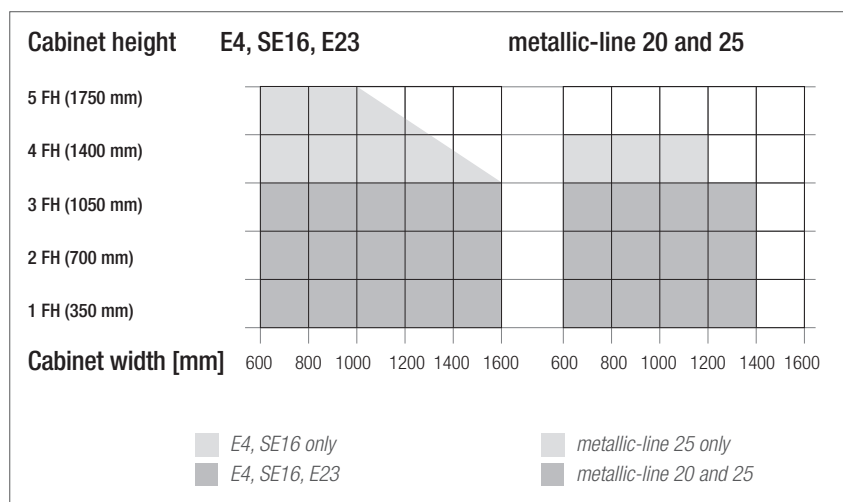





1 Track system Classic:

- recessed system
- Classical track technology



2 Track system Top:

- surface mounted guide
- Simple fitting: no routing, just cut to length, screw on – done!
- Also suitable for retrofitting

Top :

for an attractive appearance without visible transition from runner to spiral track/90° connector

Top Basic:

the economical variant
(runner + 90° connector)















3 Track system Frame:

- Front-mounted guide for a new, striking design
- New appearance in unusual framed look
- Simple fitting:
no routing, just cut to length,
screw on – done!
- Uniform front design for horizontal and vertical cabinets (RAUVOLET C3)

3

HORIZONTAL APPLICATIONS

CLASSIC

Design range	Slam rail	Glide	Pelmet
metallic-line + creative-line	 <p data-bbox="571 913 673 943">Art. 779460</p>	 <p data-bbox="884 913 986 943">Art. 779904</p>	 <p data-bbox="1279 913 1382 943">Art. 779650</p>
	 <p data-bbox="571 1211 673 1240">Art. 779480</p>	 <p data-bbox="884 1211 986 1240">Art. 779914</p>	 <p data-bbox="1279 1211 1382 1240">Art. 779650</p>
decor-line	 <p data-bbox="571 1514 673 1543">Art. 779340</p>	 <p data-bbox="884 1514 1050 1570">8 mm: Art. 779660 12 mm: Art. 779670</p>	 <p data-bbox="1279 1514 1382 1543">Art. 779360</p>
color-line	 <p data-bbox="571 1809 673 1839">Art. 779330</p>	 <p data-bbox="884 1809 1050 1865">8 mm: Art. 779660 12 mm: Art. 779670</p>	 <p data-bbox="1279 1809 1382 1839">Art. 779350</p>

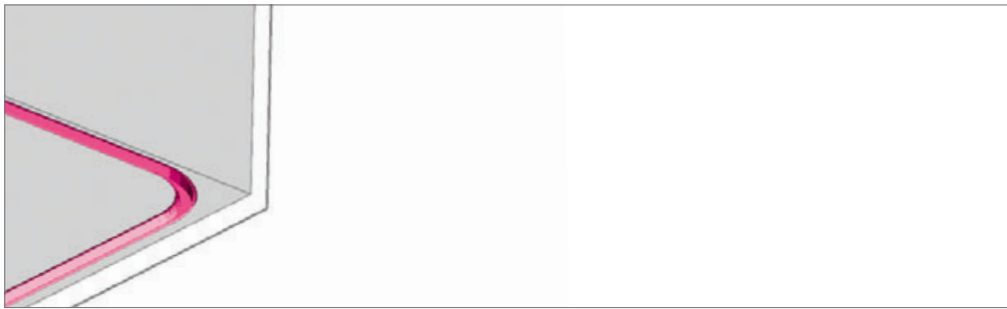

Track system

for shutter system

Track in side wall

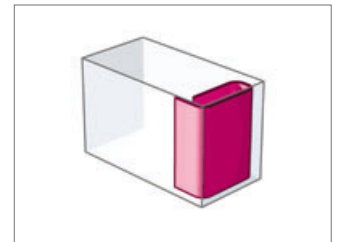

Spiral track

8 mm Art. 779730 2-course
 Art. 779750 4-course
 Art. 779770 5-course

Straight track

Art. 779370

Centre stop

Art. 779710

metallic-line,
 E23 creative-line / decor-line / color-line

12 mm Art. 779740 2-course
 Art. 779760 4-course

Art. 779380

Art. 779720

E4 / SE 16 decor-line / color-line

Track in rear wall

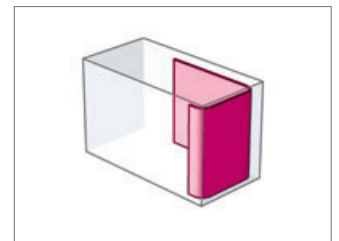
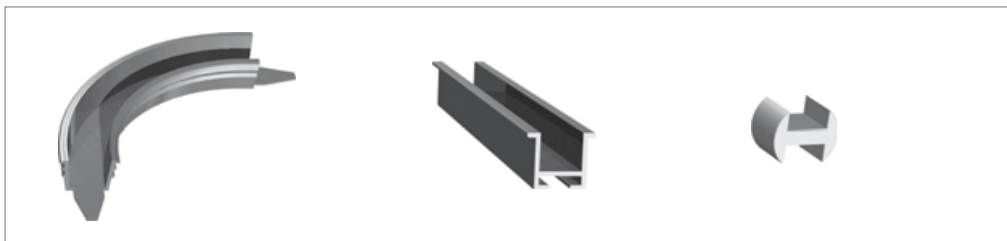

90° corner

8 mm Art. 779690

Straight track

Art. 779370

Centre stop

Art. 779710

metallic-line,
 E23 creative-line / decor-line / color-line

12 mm Art. 779700

Art. 779380











Art. 779720

E4 / SE 16 decor-line / color-line

3

HORIZONTAL APPLICATIONS

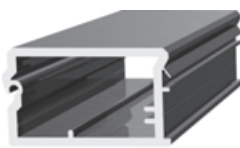
TOP + TOP BASIC

Design range	Slam rail	Glide	Pelmet
metallic-line + creative-line	 Art. 779460	 Art. 779904	 Art. 779650
	 Art. 779480	 Art. 779914	 Art. 779650
decor-line	 Art. 779340	 8 mm: Art. 779660	 Art. 779360
color-line	 Art. 779330	 8 mm: Art. 779660	 Art. 779350

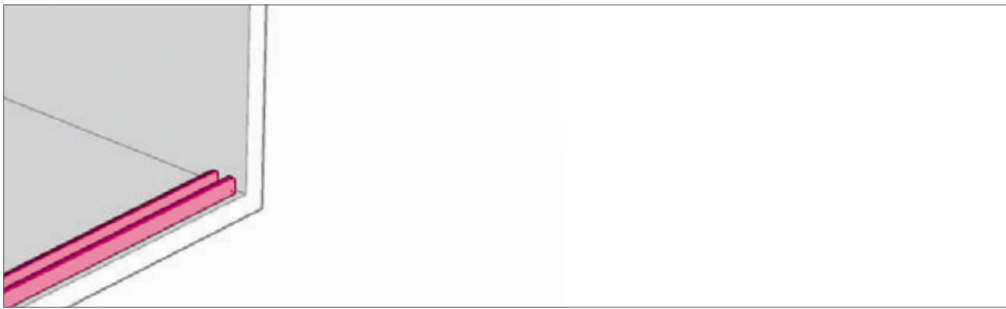

Track system

for shutter system

Top: Track in side wall

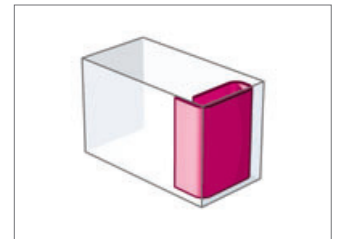
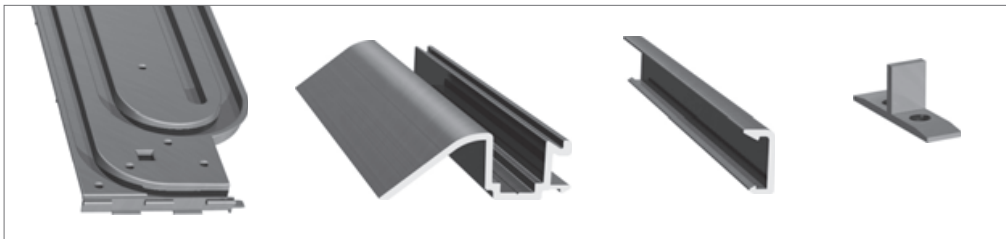

Spiral track
8mm
Art. 779620
4-course

Track
Art. 779510

Cover
Art. 779520
Art. 779540
Art. 779530

Centre stop
Art. 779980

E23 creative-line / metallic-line
E23 decor-line
E23 color-line

Top: Track in rear wall

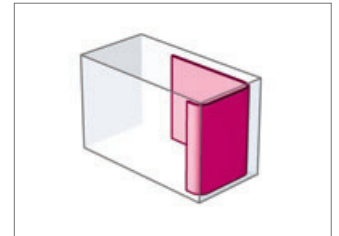
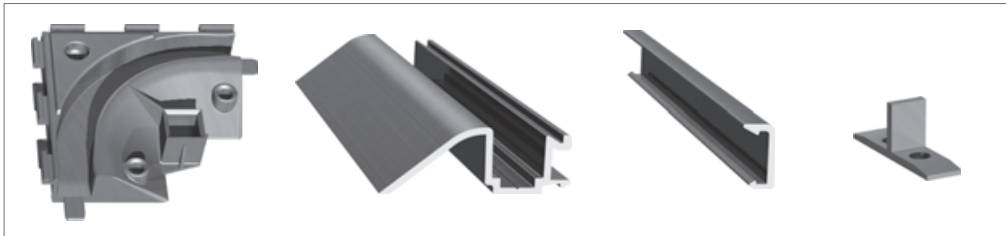

90° Corner
8mm
Art. 779974

Track
Art. 779510

Cover
Art. 779520
Art. 779540
Art. 779530

Centre stop
Art. 779980

E23 creative-line / metallic-line
E23 decor-line
E23 color-line

Top Basic: Track in rear wall:

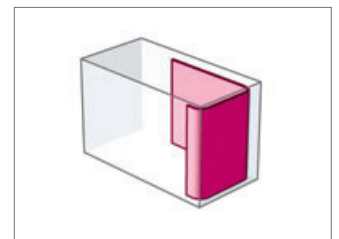
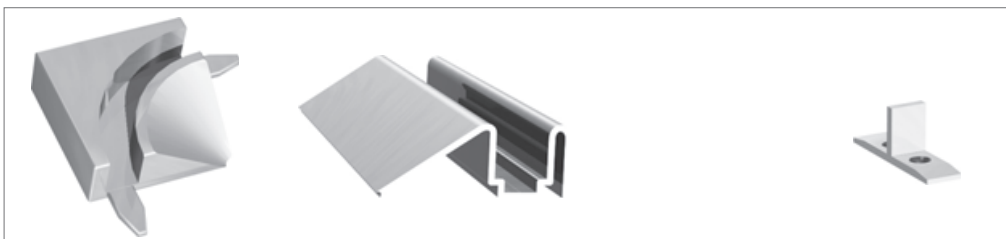

90° Corner
8mm
Art. 779950

Track
Art. 779450

Centre stop
Art. 779980

E23 decor-line / color-line

3

HORIZONTAL APPLICATIONS

FRAME

Design range	Slam rail	Glide	Pelmet
metallic-line + creative-line			
	Art. 779490	Art. 779884	Art. 779470
decor-line			
	Cover Art. 779964 Base Art.-Nr. 779944	Art. 779884	Art. 779610 Art. 779590
color-line			
	Cover Art. 779954 Base Art. 779944	Art. 779884	Art. 779600 Art. 779590

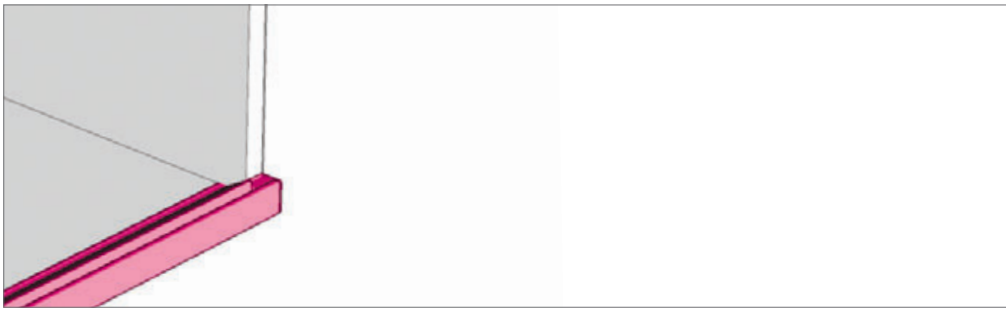

Track system

for shutter system

Track in side wall

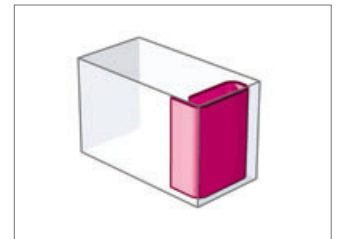
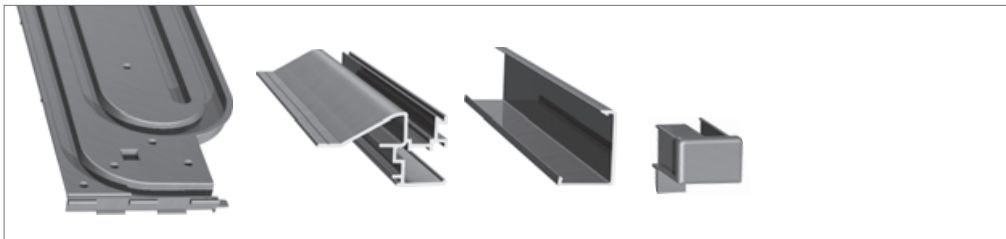

Spiral track

8 mm Art. 779620
4-course

Track

Art. 779550

Cover

Art. 779560
Art. 779580
Art. 779570

End caps

Art. 779630

E23 creative-line / metallic-line
E23 decor-line
E23 color-line

Track in rear wall

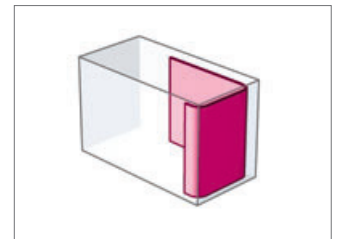
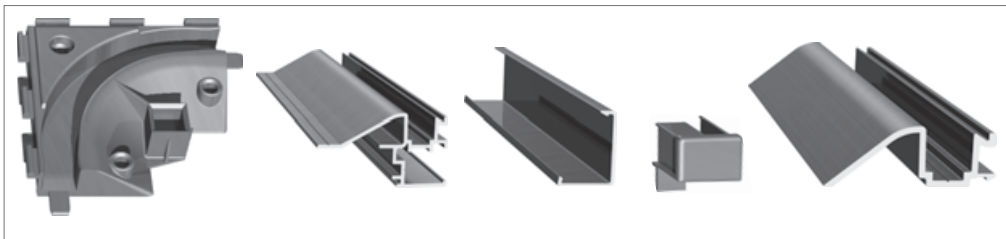

90°-Corner

8 mm Art. 779974

Track Frame

Art. 779550

Cover

Art. 779560
Art. 779580
Art. 779570

End caps

Art. 779630

Track Top

Art. 779510

E23 creative-line / metallic-line
E23 decor-line
E23 color-line

REHAU offers fully matched systems for nearly all types of vertically running roller shutters. In combination with the RAUVOLET components, this gives you unrestricted freedom in the design of your cabinet.

Our wide range of counterbalance systems mean diverse uses and fields of application for you: from the small caddy through to wall-to-wall office cabinets and to high-quality kitchens, all providing intelligent solutions.





RAUVOLET vertical brake

- Double function as slam rail glide specifically for small cabinets
- perfect running characteristics in the track system
- Slow down of the shutter door
- Brake effect at both sides, individually adjustable
- Capable of combination with the slam rails Art. 779330/779340
- For use with RAUVOLET E23



Art. 779680

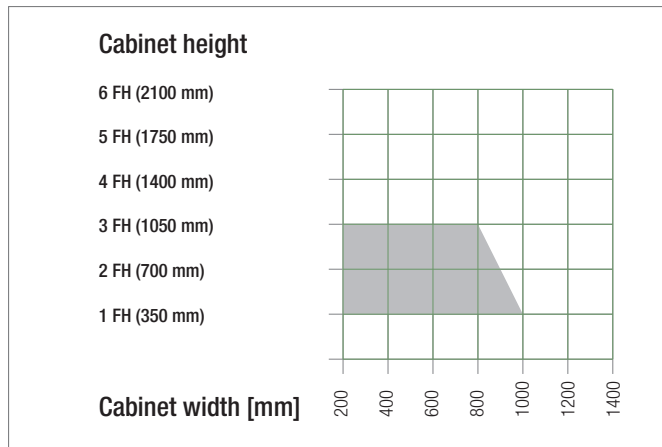

recommended for vertical applications

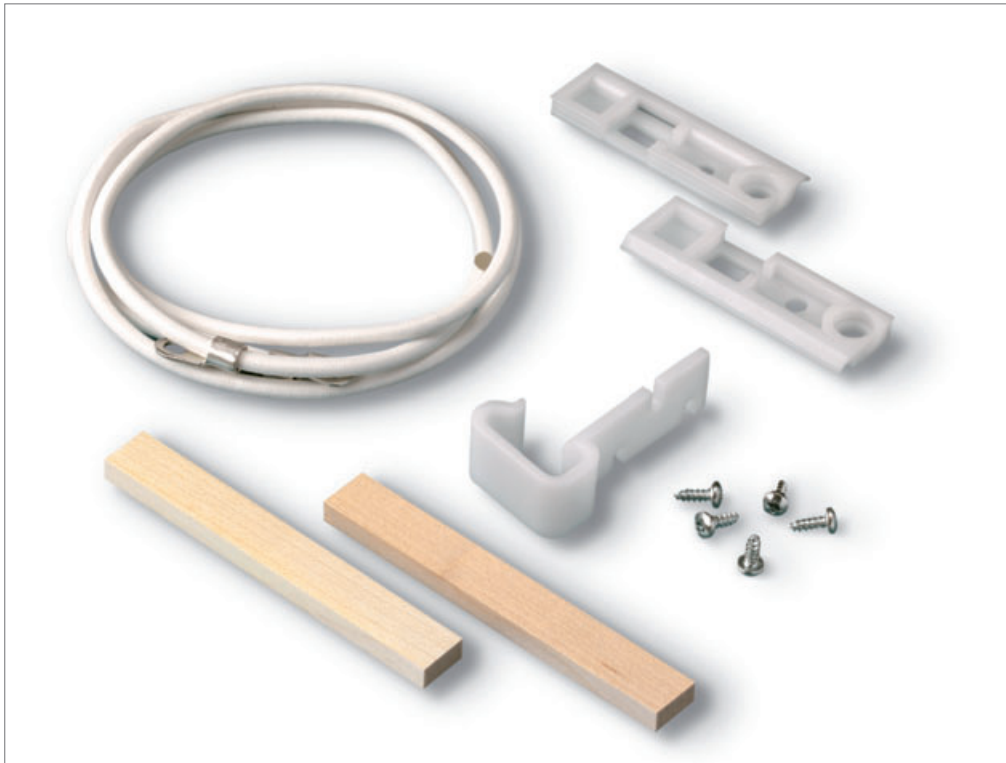

RAUVOLET C6

- For use in cabinets with recessed or surface-mounted tracks in conjunction with 90° corners
- The active counterweight for opening from the bottom upwards
- Simple solution with minimum space requirement in the cabinet
- For use with RAUVOLET E23 and metallic-line 20 mm

Art. 779970

Cabinet height

- 6 FH (2100 mm)
- 5 FH (1750 mm)
- 4 FH (1400 mm)
- 3 FH (1050 mm)
- 2 FH (700 mm)
- 1 FH (350 mm)

Cabinet width [mm]

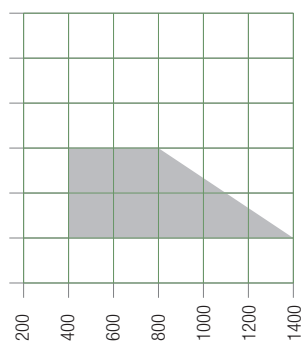

recommended for vertical applications

VERTICAL APPLICATIONS

CADDY BRAKE

RAUVOLET caddy brake (CB)

- For use in cabinets with recessed tracks and spiral tracks
- Patented brake module for direct installation
- Simple fitting with very little preparation work
- Direction of opening from the top downwards
- Adjustment from the outside in finished cabinet possible
- One brake is sufficient for each cabinet; A second brake can be installed at the opposite side (on request)
- For use with RAUVOLET E23 and metallic-line 25 mm.

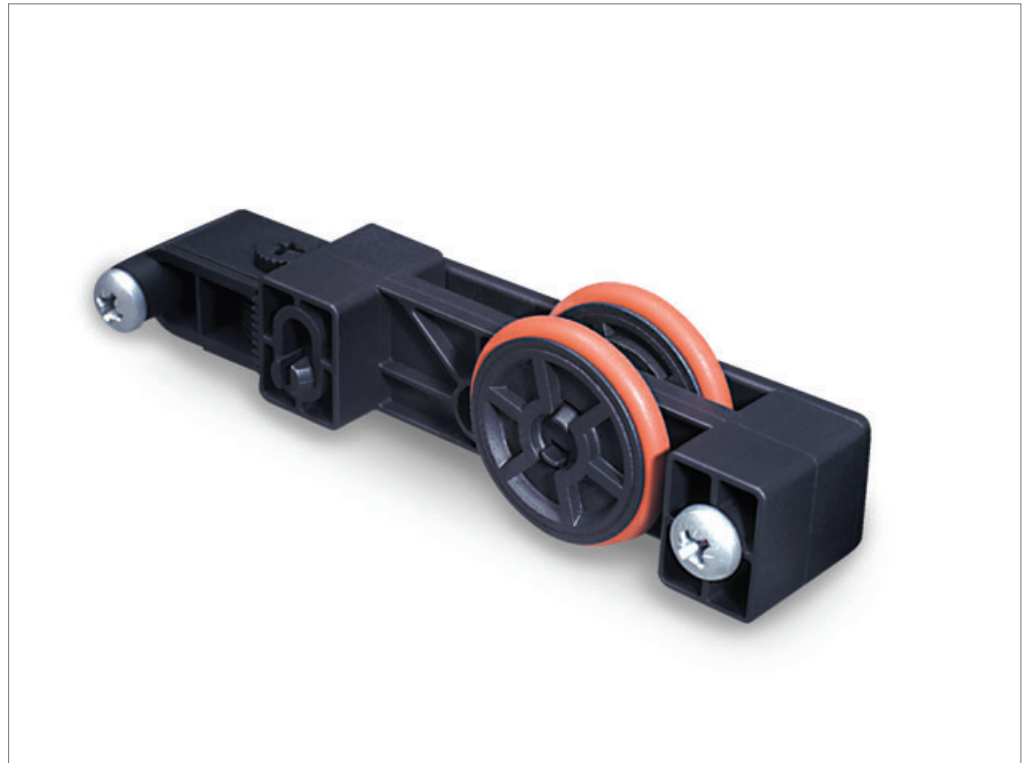

Art. 779640

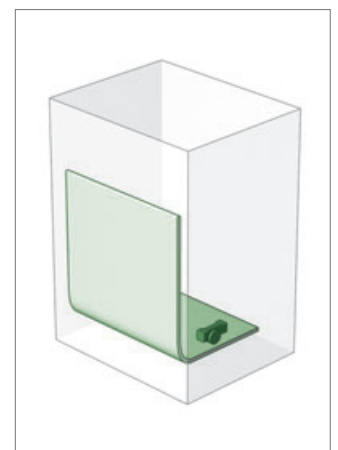
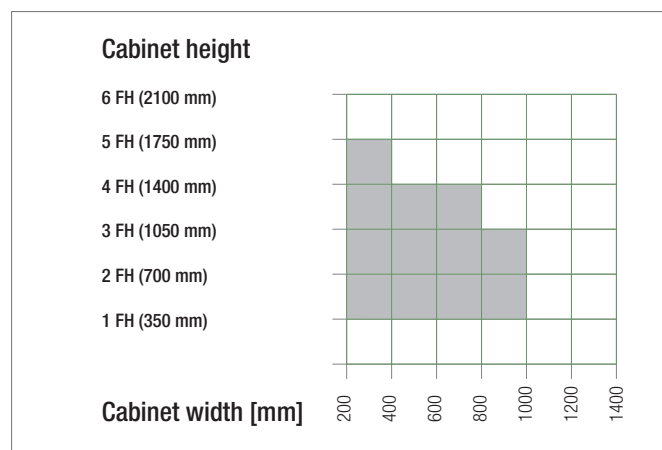

recommended for vertical applications



Combine

1 C3 roller mechanism and extension
(page 25)

2 Track system and pelmet

- a. Frame track system:
The colour of the track and pelmet can be adapted to the shutter carpet
(page 27)
- b. Aluminium track system
Track and pelmet in captivating aluminium look for design that is rich in contrast.
(pages 28-29)

3 Shutter carpet with mid grip section

Choose from the design lines metallic-line 20 and 25mm, E23 creative-line, decor-line and color-line
(pages 8-9 and 26)

4 Slam rail

Whether classic carcass design or raised floor, you are guaranteed to find the right solution.
(page 26)

Shutter carpet and slam rail

flexible choice of colour (pages 8-9 and 26)

Frame and Aluminium track systems

Frame: flexible choice of colour (pages 8-9 and 26)
Aluminium: colour E6EV1

Cabinet design

Projecting shelf or classic carcass design

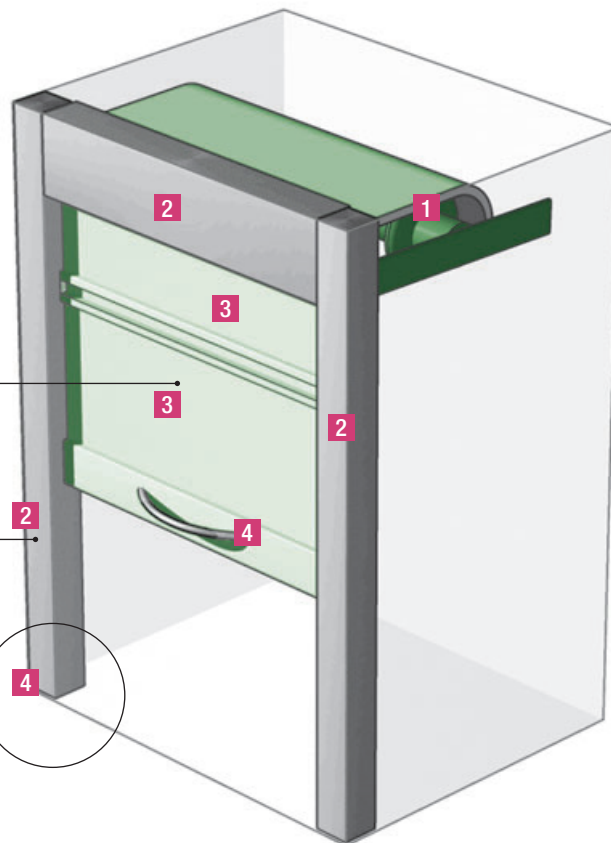

C3 Roller Mechanism



Art. see right

A proven mechanism combined with the REHAU roller shutters creates a vertical running system which fits optimally in your cabinet.

- Complete system for vertical applications
- The width-independent mechanism covers cabinets with 16 and 19 mm chipboard
- Suitable for cabinets in 4 widths (600, 800, 1000, and 1200mm) and max. 6FH
- Increased flexibility in terms of width from 350 to 1184 mm carcass inside width as a result of extension
- Optimum counterweight for the shutter by high-quality spring loaded mechanism
- Minimum space requirement for all cabinet heights due to idler roller and roller principle
- Convenient handling due to special mid grip section
- Quick and easy installation: fit set in cabinet, screw on tracks, done!
- For use with RAUVOLET E23 and metallic-line 20/25 mm

Cabinet height

- 6 OH (2100 mm)
- 5 OH (1750 mm)
- 4 OH (1400 mm)
- 3 OH (1050 mm)
- 2 OH (700 mm)
- 1 OH (350 mm)

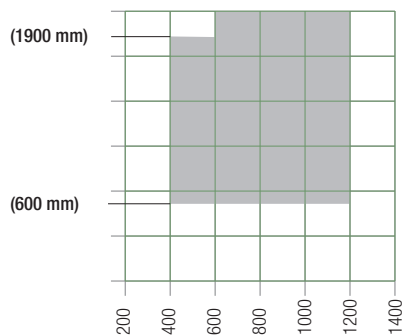

Cabinet width (outside) [mm]

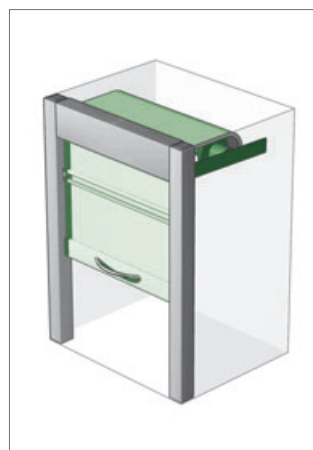

1 Mechanism

Carcass outside [mm]	Carcass inside [mm]	Art.-no.
400	350 - 384	779310
600	550 - 584	779840
800	750 - 784	779850
1000	950 - 984	779860
1200	1150 - 1184	779870

2 Extension

max.	165 mm	779320
------	--------	--------

recommended for vertical applications

4

VERTICAL APPLICATIONS

C3-ROLLER MECHANISM

CABINET DESIGNS + SLAM RAILS

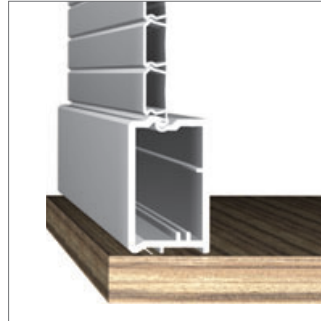

Raised floor

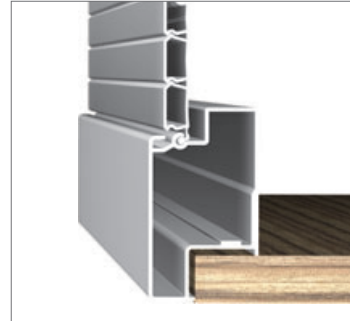

Classic carcass design

metallic-line + creative-line

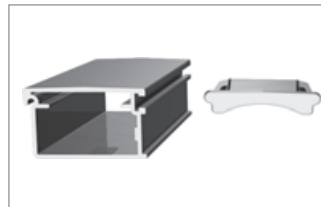

Art. 779460

Art. 779904

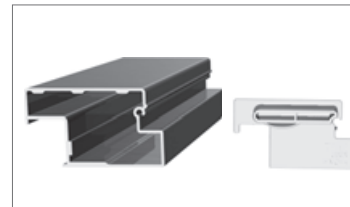

Art. 779490

Art. 779884



Art. 779930

Art. 779960

decor-line

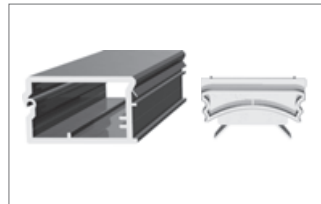

Art. 779340

Art. 779660

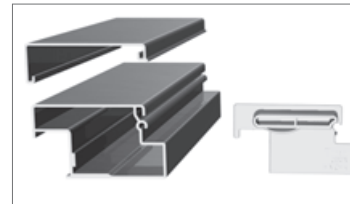

Art. 779964

Art. 779944

Art. 779884

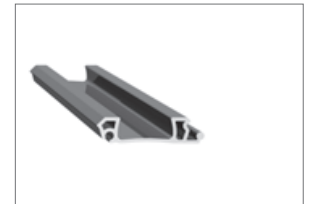

Art. 779920

Material RAU-PP

(subsequent painting not possible)

color-line

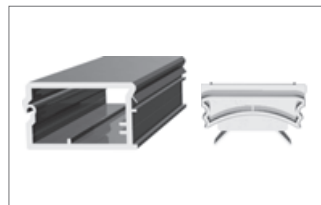

Art. 779330

Art. 779660

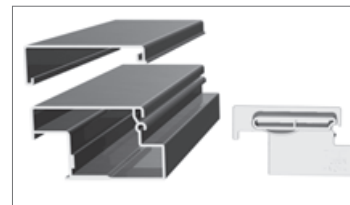

Art. 779954

Art. 779944

Art. 779884

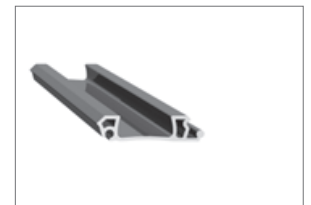

Art. 779440

Material: RAU-PVC

Design range

Slam rail glide

Slam rail glide

Mid grip glide

VERTICAL APPLICATIONS

C3-ROLLER MECHANISM TRACK SYSTEM FRAME

The colour of the Frame track system can be adapted to the roller shutters. At the same time, horizontal and vertical cabinet can be manufactured in the perfect design match.

Choose the right track from the design lines metallic-line, creative-line, decor-line and color-line.

Shutter carpet and slam rails
flexible choice of colours (p.8)

Track system
flexible choice of colours (p.8)

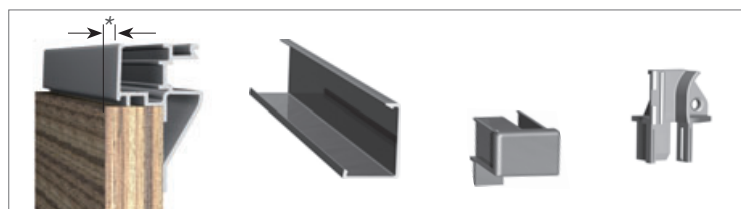
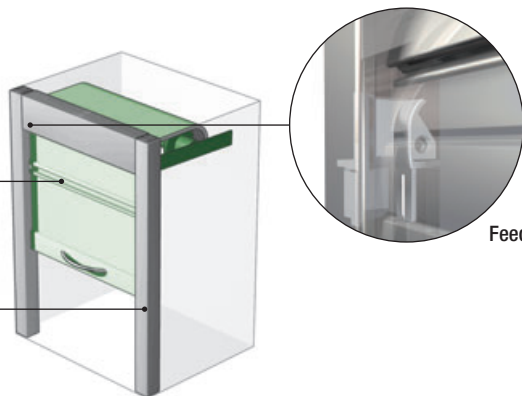

Art. 779550 Art. 779560 Art. 779630 Art. 793010

* 16 mm thickness: 1 mm
* 19 mm thickness: 4 mm
including cover



Art. 779470
colour E6EV1



E23 creative-line / metallic-line

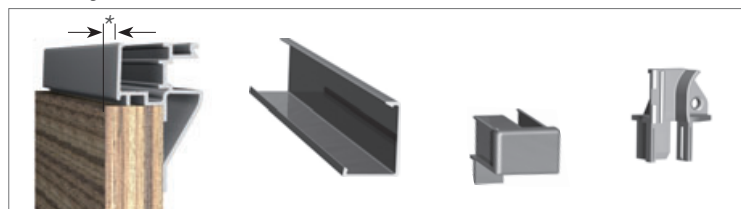

Art. 779550 Art. 779580 Art. 779630 Art. 793010

* 16 mm thickness: 1 mm
* 19 mm thickness: 4 mm
including cover



Art. 779610
Art. 779590



E23 decor-line

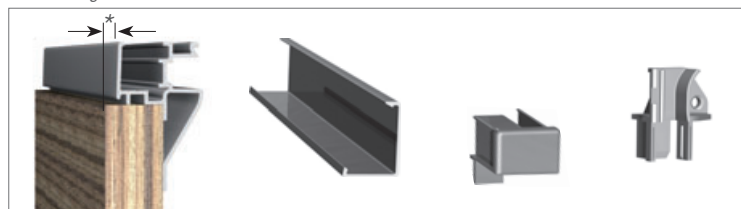

Art. 779550 Art. 779570 Art. 779630 Art. 793010

* 16 mm thickness: 1 mm
* 19 mm thickness: 4 mm
including cover

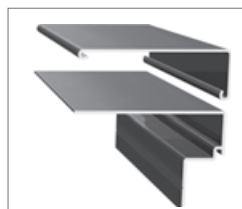

Art. 779600
Art. 779590



E23 color-line

Track	Cover	End cap	Feed	Pelmet	for roller shutter system
-------	-------	---------	------	--------	---------------------------

4

VERTICAL APPLICATIONS

C3-ROLLER MECHANISM

ALUMINIUM TRACK SYSTEM, SINGLE CARCASS DESIGN

The aluminium track system in the colour E6EV1 brings contrast to the wall unit.

Whether you design the wall unit using the single carcass or modular construction system, we always have the right solution.

metallic-line, creative-line

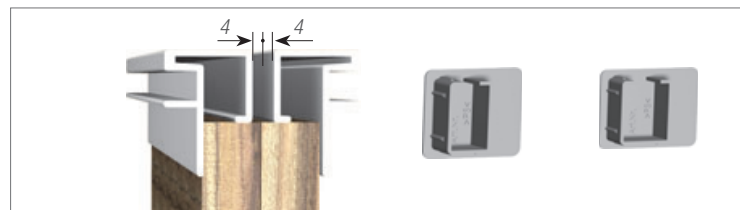

16 mm thickness
19 mm thickness

Art. 779890
Art. 779880

Art. 793040

–
Art. 793030

Art. 779470
Art. 779470

decor-line

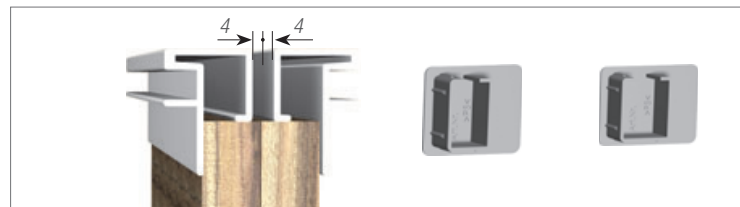

16 mm thickness
19 mm thickness

Art. 779890
Art. 779880

Art. 793040

–
Art. 793030

Art. 779470
Art. 779470

color-line

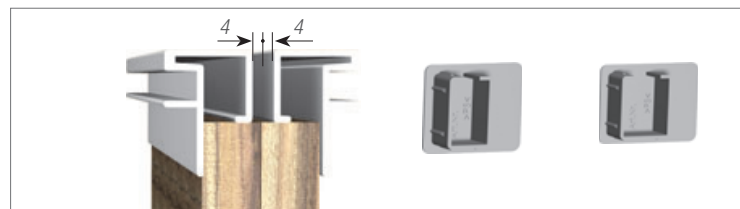

16 mm thickness
19 mm thickness

Art. 779890
Art. 779880

Art. 793040

–
Art. 793030

Art. 779470
Art. 779470

Design range	Chipboard	Track	End cap	End cap	Pelmet
--------------	-----------	-------	---------	---------	--------

VERTICAL APPLICATIONS

C3-ROLLER MECHANISM

ALUMINIUM TRACK SYSTEM, MODULAR DESIGN

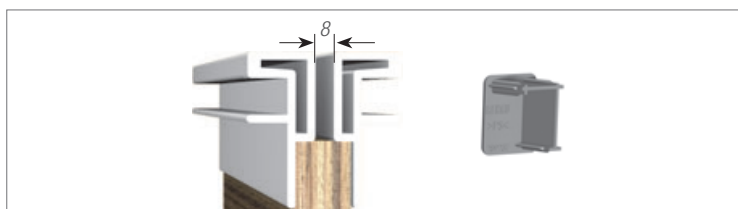
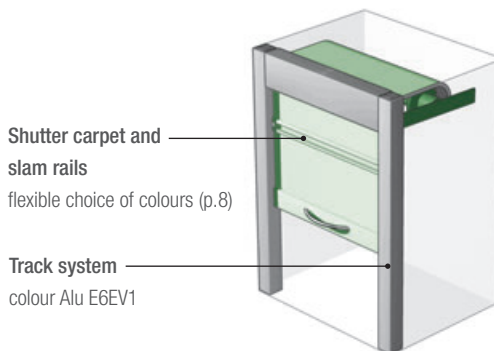

16 mm thickness
19 mm thickness

Art. 779900

Art. 793020

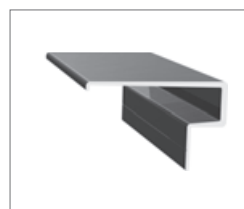

Art. 779470



E23 creative-line / metallic-line

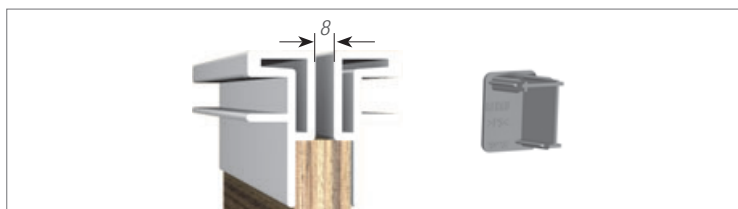

16 mm thickness
19 mm thickness

Art. 779900

Art. 793020

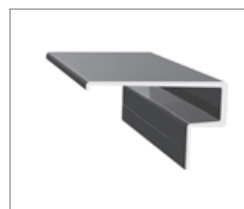

Art. 779470



E23 decor-line

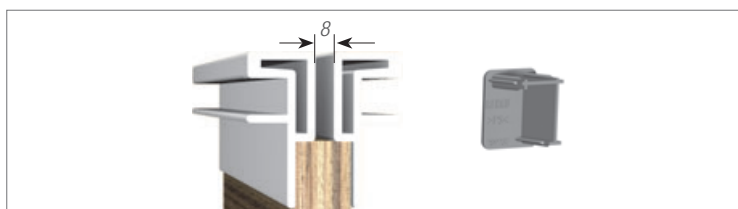

16 mm thickness
19 mm thickness

Art. 779900

Art. 793020

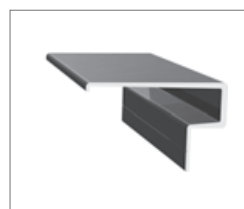

Art. 779470



E23 color-line

Chipboard	Track	End cap	Pelmet	for roller shutter system
-----------	-------	---------	--------	---------------------------

Lock

Art. 779790

**Bow handle 128 mm silver**

Art. 779800

**Bow handle 192 mm silver**

Art. 779810

**Recessed handle**

Art. 779984

Adhesive tape for all systems, 50 m roll

Art. 779390

**Damping tape**

Art. 793050

for metallic-line 20 and 25 mm in vertical application with roller mechanism C3

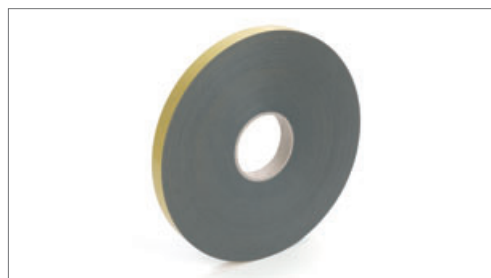

RAUVOLET is available in practical package units at short notice from stock, in the shortest possible leadtimes.

Box units:

- RAUVOLET E23, metallic-line 20/25 mm:
approx. 10 m²/box
- RAUVOLET E4/SE16:
6.75 m²/box

The shutter profiles are preassembled in elements.

Technical comments

To achieve a harmonious appearance, we recommend that shutter carpets should be assembled from the profiles of one box only due to production tolerances.

Due to the way the aluminium profiles are coated an allowance of 30 mm should be cut off both ends.



The exclusive REHAU roller shutter system RAUVOLET metallic-line combines the quiet running and comfort of polymer blinds with a high-quality look and feel, which in the past could only be

achieved with solid aluminium systems. As if that was not enough – the system also impresses with its surface stability and consistent colour stability, without losing the current “Cool Touch”.

The choice is yours!

Exclusive stainless steel appearance or cool aluminium surface. Fine 20 mm or harmonious 25 mm design.

Slam rails, running tracks and pelmets in coordinated surfaces and finishes – with the RAUVOLET metallic-line complete systems C-Box and C3 the choice is yours. You will receive the required set with all the necessary accessories ready-to-install and pre-fabricated.

Whatever you decide – all of the systems meet the most stringent quality requirements.



Ultimately REHAU know-how is „inside“.

With RAUVOLET metallic-line, REHAU makes it possible for you to unique highlights in kitchen design and increase functionality.

Whether as a top-mounted cabinet, as a wall unit or in an alcove - the variants are popular due to their innovative combinations of materials, clever processes and a fully coordinated system.

Of course RAUVOLET metallic-line also stands for sophisticated design in a flash: the system is very easy to install.

The box contains all the necessary system components for installation in the carcass – down to the last screw.

- Roller shutter system:
RAUVOLET metallic-line 20 and 25 mm
- Colours: brushed aluminium (E1EV1) and stainless steel
- Very convenient use with easy and quiet running
- Roller shutters with genuine aluminium surface
- Accessories with laminated genuine aluminium surface
- Ready to fit sets for common carcass sizes
- Simple installation
- Box with all necessary components
- Off-the-shelf programme, available immediately from 1 set

System C3

The “classic” among the assembly sets is still setting standards. This system that is tried and tested in industrial applications impresses with its comfortable running characteristics and maximum range of applications.



metallic-line 20, Art.-Nr.	metallic-line 25, Art.-Nr.
785889	785949
785909	785969
789956	789976
785929	785989
785899	785959
785919	785979
789966	789986
785939	785999

System C-Box

The cassette solution stands for design in an instant. Thanks to a completely pre-assembled system and self-explanatory fitting, installation is child’s play. In addition, the C-Box only takes up minimum space in the carcass due to its low installation height.



metallic-line 20, Art.-Nr.	metallic-line 25, Art.-Nr.
785499 (for track 784139)	785639 (for track 784139)
785529 (for track 784139)	785669 (for track 784139)
785489 (for track 784119)	785629 (for track 784119)
785519 (for track 784119)	785659 (for track 784119)

Cabinet width [mm]	Cabinet height [mm]
500	600-1000
600	
800	
900	
500	1000-1500
600	
800	
900	

ARTICLE OVERVIEW

PROFILE CROSS-SECTIONS

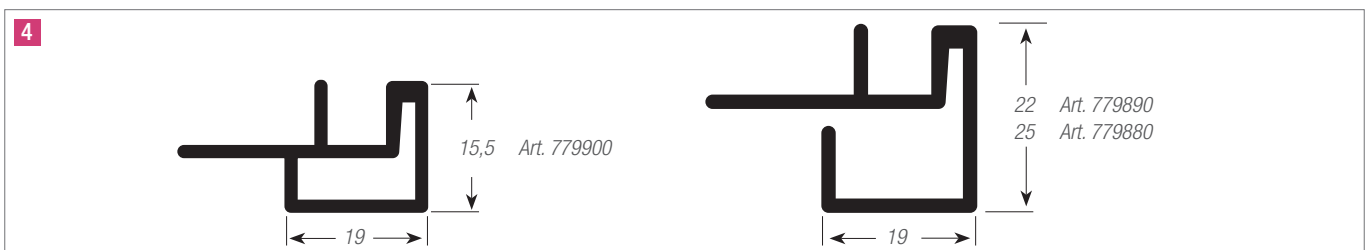
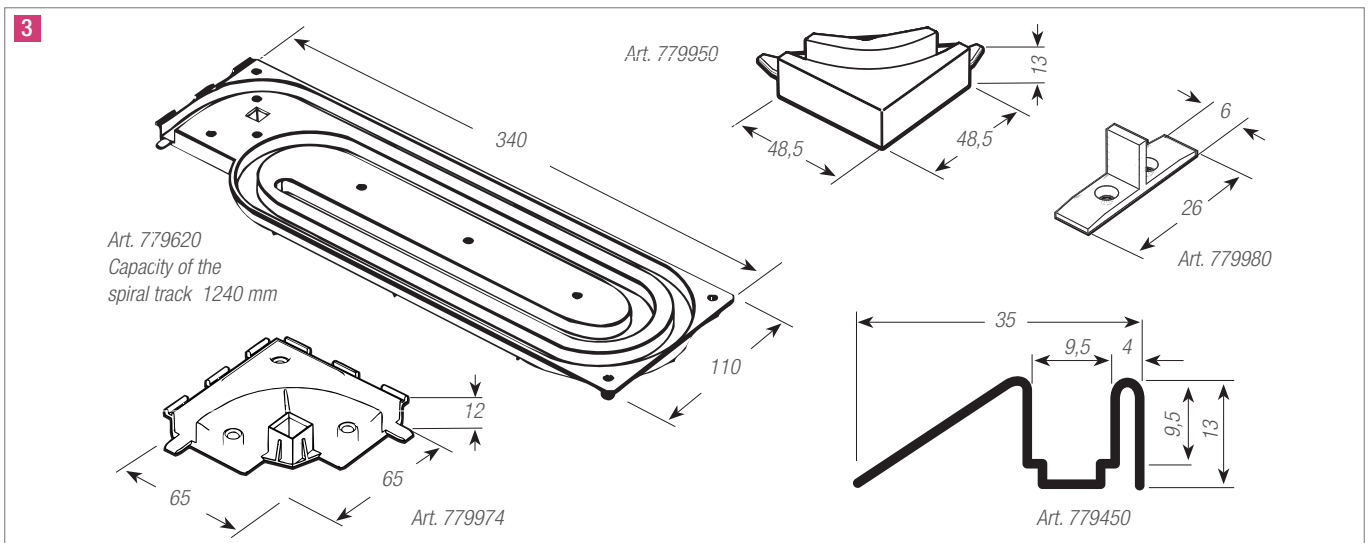
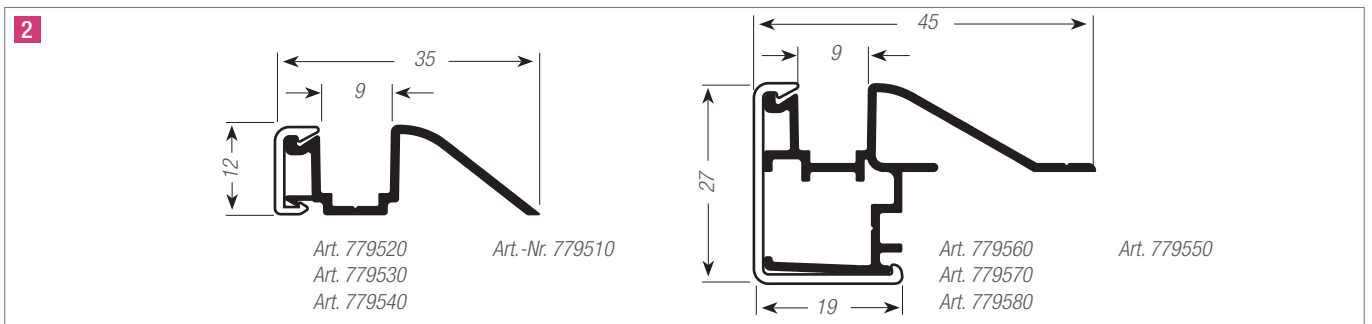
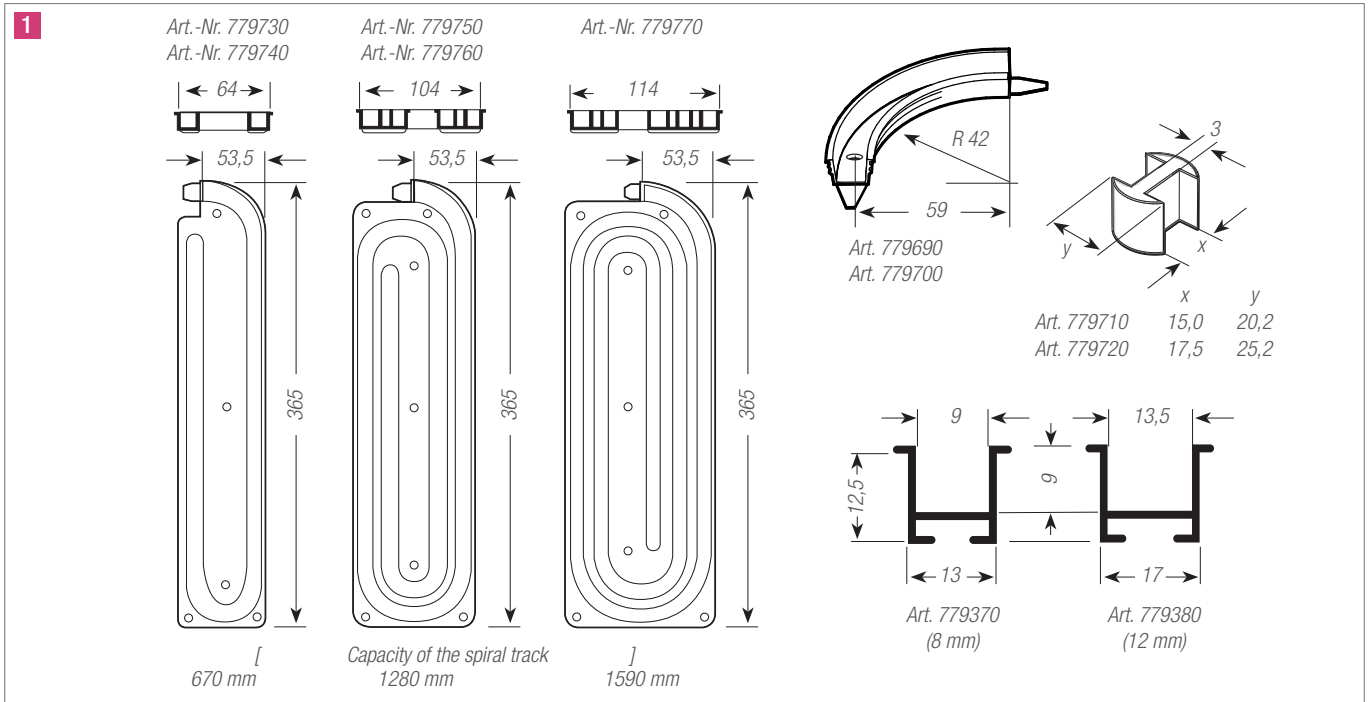

Article number	Article designation	Material	Profil length	Package unit	color-line			decor-line							creative-line	metallic-line		
					black	white	grey	aluminium decor	beech	maple	cherry	birch	cherry-Havana	calvados	white translucent	aluminium	stainless steel	
					RAL	RAL	RAL											

Roller shutter profiles																		
779040	E4 UNI	RAU-PVC	2,500 mm	45 lengths	9011		7035											
779050	E4 DECOR	RAU-PVC	2,500 mm	45 lengths				5427	5018									
779060	SE16 UNI	RAU-PVC	2,500 mm	45 lengths	9011	9010	7035											
779070	SE16 DECOR	RAU-PVC	2,500 mm	45 lengths				5427	5018									
779240	E23 UNI	RAU-PVC	2,500 mm	88 lengths	9011	9010	7035											
779250	E23 DECOR	RAU-PVC	2,500 mm	88 lengths				5427	5018	7376	5429	5514	053W	5797				
779280	E23 translucent	RAU-PVC	2,500 mm	88 lengths											20004			
779270	metallic-line 20 mm	Alu/RAU-PP	2,500 mm	240 lengths														230L (E6EV1)
779894	Shutter slide metallic-line 20 mm	RAU-POM		1000 pcs.	9011													
786065	metallic-line 25 mm	Alu/RAU-PP	2,500 mm	168 lengths														230L (E6EV1)
779924	Shutter slide metallic-line 25 mm	RAU-SB		500 pair	9011													

1	Track system Classic																	
779370	Track 8 mm	RAU-PVC	2,500 mm	20 lengths	9011	9010	7035			64881								
779380	Track 12 mm	RAU-PVC	2,500 mm	20 lengths	9011		7035											
779710	Centre stop 8 mm	RAU-PA		40 pcs.	9011	9010	7035			64881								
779720	Centre stop 12 mm	RAU-PA		40 pcs.	9011		7035											
779690	90°-connector 8 mm	RAU-PA		40 pcs.	9011	9010	7035			64881								
779700	90°-connector 12 mm	RAU-PA		40 pcs.	9011		7035											
779730	Spiral track 8 mm 2-course	RAU-PA		40 pair	9011													
779750	Spiral track 8 mm 4-course	RAU-PA		20 pair	9011		7035											
779770	Spiral track 8 mm 5-course	RAU-PA		20 pair	9011													
779740	Spiral track 12 mm 2-course	RAU-PA		40 pair	9011													
779760	Spiral track 12 mm 4-course	RAU-PA		20 pair	9011													

2	Track system Top and Frame																			
779510	Track Top Alu	ALU	2,500 mm	8 lengths	Alu 230L (E6EV1)															
779530	Cover Top Uni	RAU-PVC	2,500 mm	8 lengths	9011	9010	7035													
779540	Cover Top Decor	RAU-PVC	2,500 mm	8 lengths				5427	5018	7376	5429	5514	053W	5797						
779520	Cover Top Alu	ALU	2,500 mm	8 lengths														Alu 230L (E6EV1)		
779550	Track Frame Alu	ALU	2,500 mm	8 lengths	Alu 230L (E6EV1)															
779570	Cover Frame Uni	RAU-PVC	2,500 mm	8 lengths	9011	9010	7035													
779580	Cover Frame Decor	RAU-PVC	2,500 mm	8 lengths				5427	5018	7376	5429	5514								
779560	Cover Frame Alu	ALU	2,500 mm	8 lengths														Alu 230L (E6EV1)		
779630	End caps Frame	RAU-POM		10 Set	9011	9010	7035	38261	64881	13897	13702	63713			38261	38261				
793010	Feed Frame	RAU-POM		10 pair	9011															

3																		
779620	Spiral track Top/Frame 4-course	RAU-PA		20 pair	9011													
779974	90°-connector Top/Frame	RAU-PA		40 pcs.	9011													
779980	Centre stop Top	RAU-PA		40 pcs.	9011	9010	7035	38261	64881	13897	13702				38261	38261		
779450	Track Top Basic 8 mm	RAU-PVC	2,500 mm	20 Längen	9011	9010	7035	38261	64881	13897	13702	63713	77253	77254				
779950	90°-connector Top Basic 8 mm	RAU-PA		40 pcs.	9011	9010	7035	38261	64881	13897	13702	63713	77253	77254				

4	Track rails C3																			
779890	Track vertical 16 mm EK	ALU	2,300 mm	1 pair	Alu 230L (E6EV1)															
779880	Track vertical 19 mm EK	ALU	2,300 mm	1 pair	Alu 230L (E6EV1)															
779900	Track vertical 19 mm SW	ALU	2,300 mm	1 pair	Alu 230L (E6EV1)															
793020	End caps for track 779900	RAU-SB	15,5 mm	20 pair	RAL 9006															
793030	End caps for track 779880	RAU-SB	15,5 mm	20 pair	RAL 9006															
793040	End caps for track 779890	RAU-SB	15,5 mm	20 pair	RAL 9006															

ARTICLE OVERVIEW

PROFILE CROSS-SECTIONS

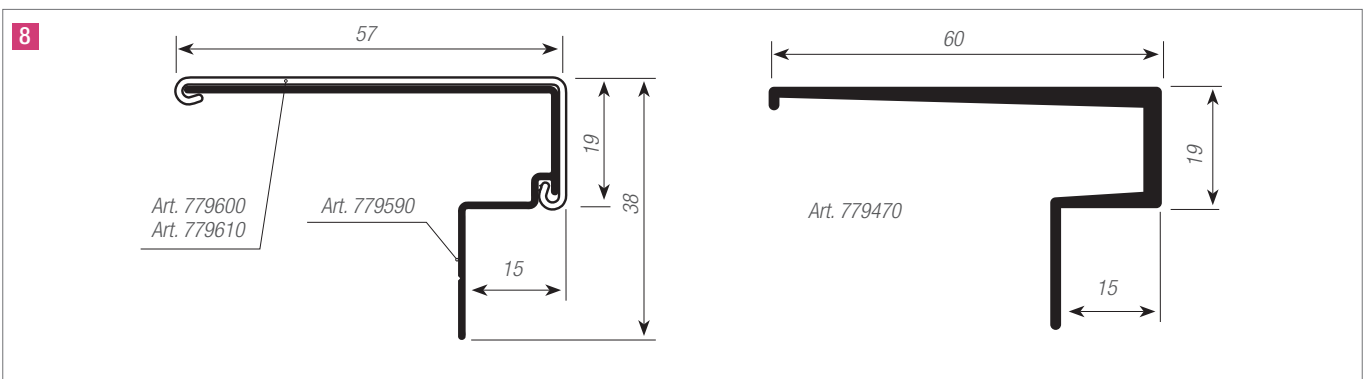
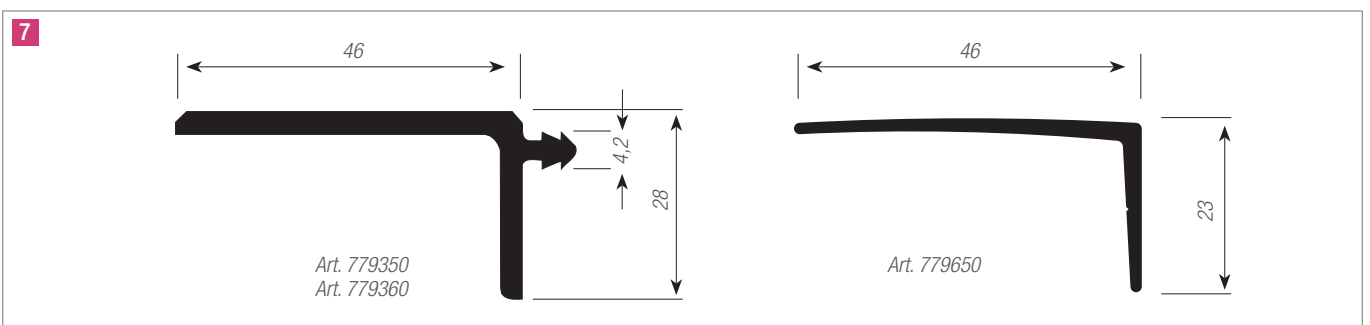
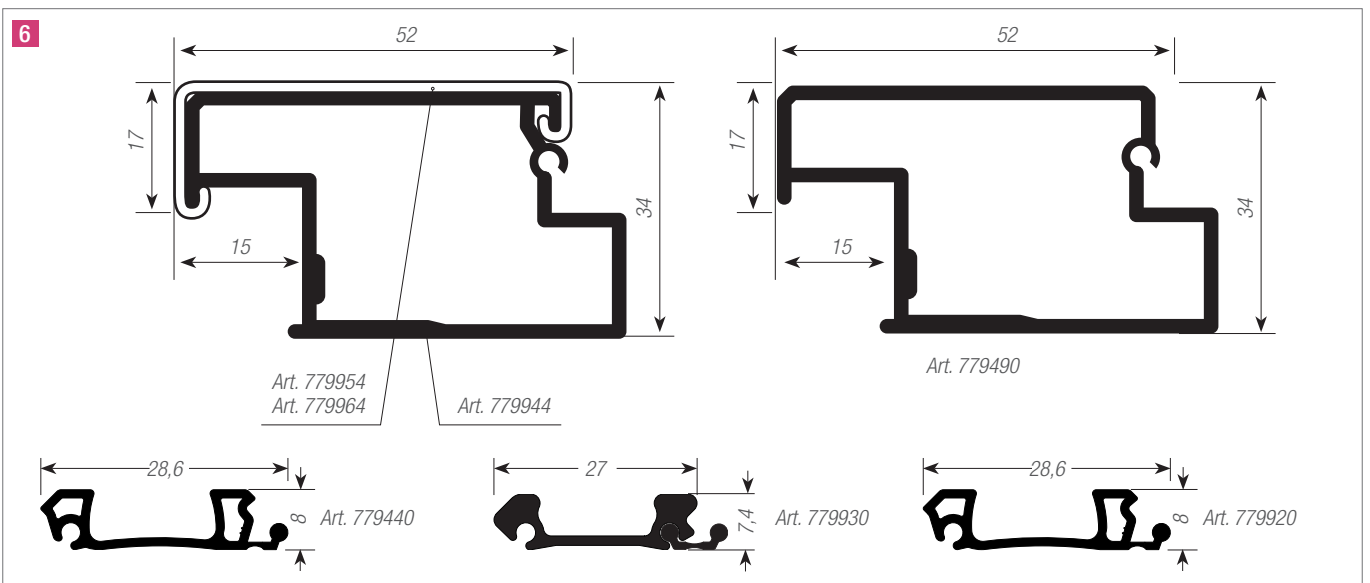
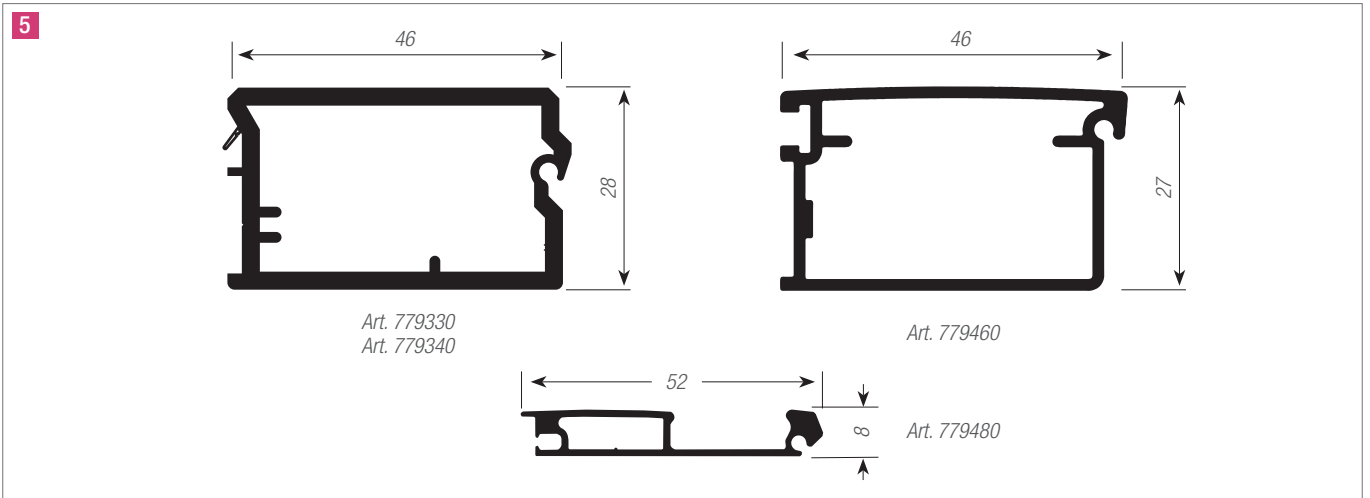

Article number	Article designation	Material	Profil length	Package unit	color-line			decor-line							creative-line	metallic-line	
					black	white	grey	aluminium decor	beech	maple	cherry	birch	cherry-Havana	calvados		white translucent	aluminium
					RAL	RAL	RAL										
Counterbalance systems																	
779640	Caddy brake (installation right)	RAU-POM		10 pcs.	9011												
779680	Vertical brake E23	RAU-POM		20 pairs	9011	9010	7035		64881								
779970	Counterbalance mechanism C6			5 pcs.													
779310	Counterbal. mecha. C3 width 400 mm			1 pc.													
779840	Counterbal. mecha. C3 width 600 mm			1 pc.													
779850	Counterbal. mecha. C3 width 800 mm			1 pc.													
779860	Counterbal. mecha. C3 width 1000 mm			1 pc.													
779870	Counterbal. mecha. C3 width 1200 mm			1 pc.													
779320	Extension C3			1 pair													
5 Slam rails/pelmets																	
779330	Slam rail UNI	RAU-PVC	2,500 mm	8 lengths	9011	9010	7035										
779340	Slam rail DECOR	RAU-PVC	2,500 mm	8 lengths				5427	5018	7376	5429	5514	053W	5797			
779660	Slam rail glide 8 mm	RAU-POM		20 pairs	9011	9010	7035		64881								
779670	Slam rail glide 12 mm	RAU-POM		20 pairs	9011	9010	7035		64881								
779460	Slam rail Alu	ALU	2,500 mm	8 lengths													Alu 230L (E6EV1)
779904	Slam rail glide Alu	RAU-POM		20 pairs	9011												
779480	Combo Slam rail	ALU	2,500 mm	8 lengths													Alu 230L (E6EV1)
779914	Combo Slam rail glide	RAU-POM		20 pairs			7037										
6																	
779944	Slam rail, overlapping Alu Base	ALU	2,500 mm	8 lengths	Alu pressblank (E0/CO)												
779954	Slam rail, overlapping cover UNI	RAU-PVC	2,500 mm	8 lengths	9011	9010	7035										
779964	Slam rail, overlapping cover DECOR	RAU-PVC	2,500 mm	8 lengths				5427	5018	7376	5429	5514					
779490	Slam rail, overlapping Alu	ALU	2,500 mm	8 lengths													Alu 230L (E6EV1)
779884	Slam rail, overlapping, glide	RAU-POM		20 pairs	9011		7035		64881								RAL7035
779440	Midgrip Uni	PVC/PP	1,174 mm	10 pcs.	9011	9010	7035										
779920	Midgrip Decor	RAU-PP						7194	5018								
779930	Midgrip Alu with adapter profile	ALU/RAU-PP															Alu 230L (E6EV1)
779960	Slam rail for mid grip Art. 779930	PA			9011												
7																	
779350	Pelmet UNI	RAU-PVC	2,500 mm	8 lengths	9011	9010	7035										
779360	Pelmet DECOR	RAU-PVC	2,500 mm	8 lengths				5427	5018	7376	5429	5514	053W	5797			
779650	Pelmet Alu	ALU	2,500 mm	8 lengths													Alu 230L (E6EV1)
8																	
779590	Pelmet, overlapping ALU Base	ALU	2,500 mm	8 lengths	Alu pressblank (E0/CO)												
779600	Pelmet, overlapping cover UNI	RAU-PVC	2,500 mm	8 lengths	9011	9010	7035										
779610	Pelmet, overlapping cover DECOR	RAU-PVC	2,500 mm	8 lengths				5427	5018	7376	5429	5514					
779470	Pelmet, overlapping ALU	ALU	2,500 mm	8 lengths													Alu 230L (E6EV1)
Accessories																	
779390	Adhesive tape 50m			1 pc.													
779790	Lock			20 pcs.													
779800	Bow handle silver 128mm			20 pcs.													
779810	Bow handle silver 192mm			20 pcs.													
779984	Recessed handle			20 pcs.				9006									
Sets Metallic-Line																	
	see p.33																

EXPRESS COLLECTION

EVERY ASPECT

Everything from one source; in small quantities and readily available

Express Collection standard range

The RAUVOLET roller shutter systems are only one element of the Express Collection, as the Express Collection, with a comprehensive package of products and services, has much more to offer you.

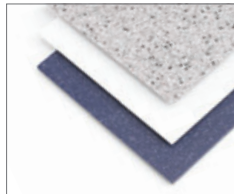

- RAUKANTEX edgeband materials and tools
- RAUVOLET roller shutter systems
- Hardware components
- RAUKANTEX solid surface materials and tools
- RAUWALON wall seal systems
- Plinth covers

Further training, technical advice and processing support

The REHAU Academy



The REHAU Academy has established itself as the forum for trade and creative interior design. Mobile, flexible and informative – events and seminars take place under these catchwords at which our furniture specialists pass on their technical expertise, describe processing and installation situations and offer easily achievable solutions. The focus is always on the practical application. All subjects are demonstrated live and visitors naturally also have the possibility of testing what they have been shown for themselves.

Current information on the latest trends in the furniture market and product innovations

The magazine „Design for furniture“



REHAU provides information twice yearly on new products and current trends in the magazine „Design for furniture“. The reader from industry, commerce and trade receives innovative tips and valuable advice on practical product applications. The magazine will always keep you up to date.

A comprehensive information and download centre. You can place orders around the clock.

The REHAU customer portal



express-collection@rehau.com:

The email address for all questions relating to the product range and service of the REHAU Express Collection

The REHAU customer portal is a comprehensive information and download centre for trade and creative interior design. Particularly as our distributor, you will receive direct access to a variety of important functions and data that make your daily work easier. It is possible to place orders around the clock, for example.

REHAU SALES OFFICES

A: Linz, Tel.: +43 7229 73658, linz@rehau.com **Vienna**, Tel.: +43 2236 24684, wien@rehau.com **AUS: Adelaide**, Tel.: +61 8 82990031, adelaide@rehau.com **Brisbane**, Tel.: +61 7 38897522 brisbane@rehau.com **Melbourne**, Tel.: +61 3 95875544, melbourne@rehau.com **Perth**, +61 8 93372300, perth@rehau.com **Sydney**, Tel.: +61 2 97481788, sydney@rehau.com **B: Brussels**, Tel.: +32 16 3999-11, bruxelles@rehau.com **BG: Sofia**, Tel.: +359 2 96557-71, sofia@rehau.com **BIH: Sarajevo**, Tel.: +387 33 475-500, sarajevo@rehau.com **BR: Arapongas**, Tel.: +55 43 32742004, arapongas@rehau.com **Caxias do Sul**, Tel.: +55 54 32146606, caxiasdosul@rehau.com **Mirassol**, Tel.: +55 17 32535190, mirassol@rehau.com **Sao Paulo**, Tel.: +55 11 461339- 22, saopaulo@rehau.com **BY: Minsk**, Tel.: +375 17 2350228, minsk@rehau.com **CDN: Moncton**, Tel.: +1 506 5382346, moncton@rehau.com **Montreal**, Tel.: +1 514 9050345, montreal@rehau.com **St. John's**, Tel.: +1 709 7473909, stjohns@rehau.com **Toronto**, Tel.: +1 905 3353284, toronto@rehau.com **Vancouver**, Tel.: +1 604 6264666, vancouver@rehau.com **Winnipeg**, Tel.: +1 204 6972028, winnipeg@rehau.com **CH: Berne**, Tel.: +41 31 7202-120, bern@rehau.com **Vevey**, Tel.: +41 21 94826-36, vevey@rehau.com **Zurich**, Tel.: +41 44 83979-79, zuerich@rehau.com **CZ: Brno**, Tel.: +420 547 425-580, brno@rehau.com **Prague**, Tel.: +420 2 72190-111, praha@rehau.com **D: Berlin**, +49 30 66766-0, berlin@rehau.com **Bielefeld**, Tel.: +49 521 20840-0, bielefeld@rehau.com **Bochum**, Tel.: +49 234 68903-0, bochum@rehau.com **Frankfurt**, Tel.: +49 6074 4090-0, frankfurt@rehau.com **Hamburg**, Tel.: +49 40 733402-0, hamburg@rehau.com **Hanover**, Tel.: +49 5136 891-0, hannover@rehau.com **Leipzig**, Tel.: +49 34292 82-0, leipzig@rehau.com **Munich**, Tel.: +49 8102 86-0, muenchen@rehau.com **Nuremberg**, Tel.: +49 9131 93408-0, nuernberg@rehau.com **Stuttgart**, Tel.: +49 7159 1601-0, stuttgart@rehau.com **DK: Copenhagen**, Tel.: +45 46 7737-00, kobenhavn@rehau.com **E: Barcelona**, Tel.: +34 93 63535 00, barcelona@rehau.com **Bilbao**, Tel.: +34 94 45386-36, bilbao@rehau.com **Madrid**, Tel.: +34 91 6839425, madrid@rehau.com **EST: Tallinn**, Tel.: +372 6 2839-32, tallinn@rehau.com **F: Agen**, Tel.: +33 553695869, agen@rehau.com **Lyon**, Tel.: +33 472026-300, lyon@rehau.com **Paris**, Tel.: +33 1 348364 50, paris@rehau.com **Rennes**, Tel.: +33 2 996521-30, rennes@rehau.com **St. Avold**, Tel.: +33 3879177-00, stavold@rehau.com **FI: Helsinki**, Tel.: +358 9 877099-00, helsinki@rehau.com **GB: Birmingham**, Tel.: +44 121 34423 00, birmingham@rehau.com **Glasgow**, Tel.: +44 1698 503 700, glasgow@rehau.com **Manchester**, Tel.: +44 161 7777-400, manchester@rehau.com **Slough**, Tel.: +44 1753 5885-00, slough@rehau.com **GE: Tiflis**, Tel.: +995 32 559909, tbilisi@rehau.com **GR: Athens**, Tel.: +30 210 6682-500, athens@rehau.com **H: Budapest**, Tel.: +36 23 5307-00, budapest@rehau.com **HK: Hongkong**, Tel.: +8 52 28987080, hongkong@rehau.com **HR: Zagreb**, Tel.: +3 85 1 3886998, zagreb@rehau.com **I: Milan**, Tel.: +39 02 95941-1, milano@rehau.com **Pesaro**, Tel.: +39 0721 2006-11, pesaro@rehau.com **Rome**, Tel.: +39 06 900613-11, roma@rehau.com **Treviso**, Tel.: +39 0422 7265-11, treviso@rehau.com **IND: New Delhi**, Tel.: +91 11 30948602, newdelhi@rehau.com **Mumbai**, Tel.: +91 22 55922929, mumbai@rehau.com **IRL: Dublin**, Tel.: +353 1 816502-0, dublin@rehau.com **J: Osaka**, Tel.: +81 3 57962102, osaka@rehau.com **KAS: Almaty**, Tel.: +7 3272 461943, almaty@rehau.com **LT: Vilnius**, Tel.: +3 705 24614-00, vilnius@rehau.com **LV: Riga**, Tel.: +3 71 7 609080, riga@rehau.com **MK: Skopje**, Tel.: +3 892 2402-670, skopje@rehau.com **MEX: Mexico**, Tel.: +52 461 61880-00, mexico@rehau.com **Monterrey**, Tel.: +52 81 81210-130, monterrey@rehau.com **N: Oslo**, Tel.: +47 22 5141-50, oslo@rehau.com **NL: Nijkerk**, Tel.: +31 33 24799-11, nijkerk@rehau.com **NZ: Auckland**, Tel.: +64 9 2712715, auckland@rehau.com **P: Lisbon**, Tel.: +3 51 21 94972-20, lisbao@rehau.com **PE: Lima**, Tel.: +51 1 2261713, lima@rehau.com **PL: Danzig**, Tel.: +48 58 668 59 60, gdynia@rehau.com **Kattowitz**, Tel.: +48 32 7755-100, katowice@rehau.com **Posen**, Tel.: +48 61 849-8400, poznan@rehau.com **Warsaw**, Tel.: +48 22 519-7300, warszawa@rehau.com **RA: Buenos Aires**, Tel.: +54 11 489860-00, buenosaires@rehau.com **RC: Taipei**, Tel.: +886 2 25861210, taipei@rehau.com **RCH: Santiago**, Tel.: +56 2 540-1900, santiago@rehau.com **RI: Jakarta**, Tel.: +62 21 5275177, jakarta@rehau.com **RO: Bacau**, Tel.: +40 234 512066, bacau@rehau.com **Bucharest**, Tel.: +40 21 2665180, bucuresti@rehau.com **Cluj**, Tel.: +40 264 415211, clujnapoca@rehau.com **ROK: Seoul**, Tel.: +82 2 5011656, seoul@rehau.com **RUS: Jekatarinburg**, Tel.: +7 343 3777344, jekatarinburg@rehau.com **Krasnodar**, Tel.: +7 861 2103636, krasnodar@rehau.com **Moscow**, Tel.: +7 495 9375250, moscow@rehau.com **Nishnij Nowgorod**, Tel.: +7 8312 786927, nishnijnowgorod@rehau.com **Nowosibirsk**, Tel.: +7 383 2000353, nowosibirsk@rehau.com **Rostow at the Don**, Tel.: +7 8632 978444, rostow@rehau.com **Samara**, Tel.: +7 8462 702590, samara@rehau.com **St. Petersburg**, Tel.: +7 812 7187501, stpetersburg@rehau.com **S: Örebro**, Tel.: +46 19 2064-00, oerebro@rehau.com **SCG: Belgrade**, Tel.: +3 81 11 3770-300, beograd@rehau.com **SGP: Singapore**, Tel.: +65 63926006, singapore@rehau.com **SK: Bratislava**, +4 21 2 682091-10, bratislava@rehau.com **T: Bangkok**, Tel.: +66 2 7443155, bangkok@rehau.com **TR: Ankara**, Tel.: +90 312 4726950, ankara@rehau.com **Istanbul**, Tel.: +90 212 35547-00, istanbul@rehau.com **Izmir**, Tel.: +90 232 4458525, izmir@rehau.com **UA: Dnepropetrowsk**, Tel.: +380 56 3705028, dnepropetrowsk@rehau.com **Kiew**, Tel.: +380 44 4677710, kiew@rehau.com **Odessa**, Tel.: +380 48 7860167, odessa@rehau.com **UAE: Dubai**, Tel.: +9714 88356 77 **USA: Chicago**, Tel.: +1 630 317 3500, chicago@rehau.com **Dallas**, Tel.: +1 972 270 2322, dallas@rehau.com **Detroit**, Tel.: +1 248 848 9100, detroit@rehau.com **Grand Rapids**, Tel.: +1 616 285 6867, grandrapids@rehau.com **Greensboro**, Tel.: +1 336 852 2023, greensboro@rehau.com **Los Angeles**, Tel.: +1 951 549 9017, losangeles@rehau.com **Minneapolis**, Tel.: +1 763 585 1380, minneapolis@rehau.com **VRC: Guangzhou**, Tel.: +86 20 87760 343, guangzhou@rehau.com **Peking**, Tel.: +86 10 84562 904, beijing@rehau.com **Shanghai**, Tel.: +86 21 6355 1155, shanghai@rehau.com **ZA: Durban**, Tel.: +27 31 70130 50, durban@rehau.com **Johannesburg**, Tel.: +27 11 201-1300, johannesburg@rehau.com



THE EXPRESS COLLECTION AT A GLANCE

ANY FURTHER QUESTIONS?



RAUKANTEX edgeband materials and tools



RAUVOLET roller shutter systems

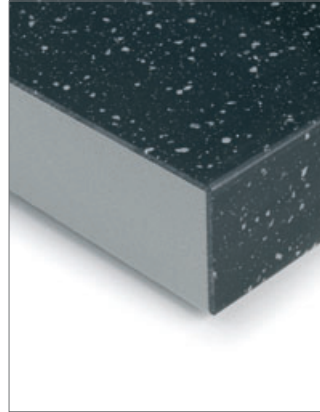

RAUSOLID solid surface materials and tools



Hardware components



RAUWALON wall seal systems



Plinth covers

For further information on our products and partners, please contact your local REHAU sales office (see page 40) or express-collection@rehau.com.

Quick, flexible, small quantities

This document is protected by copyright. All rights based on this are reserved. No part of this publication may be translated, reproduced or transmitted in any form or by any similar means, electronic or mechanical, photocopying, recording or otherwise, or stored in a data retrieval system.

Our verbal and written advice relating to technical applications is based on experience and is to the best of our knowledge correct but is given without obligation.

The use of REHAU products in conditions that are beyond our control or for applications other than those specified releases us from any obligation in regard to claims made in respect of the products.

We recommend that the suitability of any REHAU product for the intended application should be checked. Utilization and processing of our products are beyond our control and are therefore exclusively your responsibility. In the event that a liability is nevertheless considered, any compensation will be limited to the value of the goods supplied by us and used by you.

Our warranty assumes consistent quality of our products in accordance with our specification and in accordance with our general conditions of sale.

Distributors